



Product Type: Direct crimp connectors

Product Name:DL508H2XXM-
BK-XY10

Product Description: Pitch:5.08mm

RatedVoltage : 600V Double-level CE

Product Size

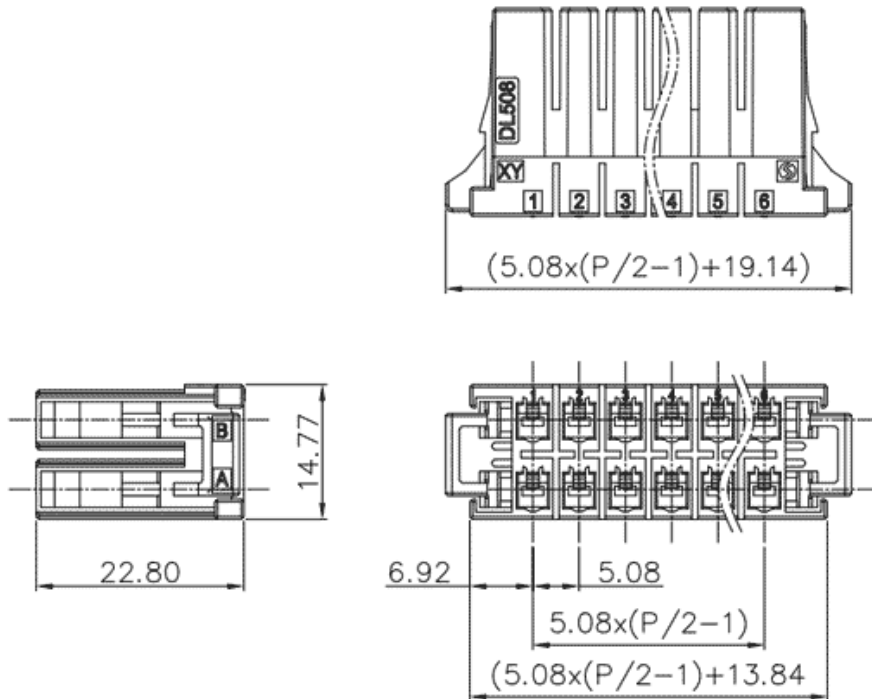

Parameters

<input checked="" type="checkbox"/> SUPU ID	DL508H2XXM-BK-XY10
<input checked="" type="checkbox"/> Pitch	5.08
<input checked="" type="checkbox"/> Number of levels	Multiple layer
<input checked="" type="checkbox"/> Number of connections	XX

<input type="checkbox"/> Connection method	Cold pressing
<input type="checkbox"/> Protection Level	IP20
<input type="checkbox"/> Operating temperature range	-40~+105°C
<input type="checkbox"/> Insulation material	PBT
<input type="checkbox"/> Insulation material group	II
<input type="checkbox"/> Contact material	-
<input type="checkbox"/> Contact plating	-

Technical data

<input type="checkbox"/> IEC Rated Current	-
<input type="checkbox"/> IEC Rated Voltage	320V
<input type="checkbox"/> Overvoltage category	III/III/ II
<input type="checkbox"/> Degree of pollution	3 2 2
<input type="checkbox"/> Rated impulse voltage	4KV 4KV 4KV
<input type="checkbox"/> UL Rated Current	-
<input type="checkbox"/> UL Rated Voltage	600V
<input type="checkbox"/> Conductor cross section rigid	-
<input type="checkbox"/> Conductor cross section flexible	-
<input type="checkbox"/> Conductor cross section flexible,with furrule	-
<input type="checkbox"/> Locking screw Specification	-
<input type="checkbox"/> Locking screw torque	-
<input type="checkbox"/> Fixed Screw Specification	-
<input type="checkbox"/> 固定螺钉扭矩	-
<input type="checkbox"/> Stripping length	-

Use group -

Rated cross section -

Commercial data

Order No

DL508H2XXM-BK-XY10

Ningbo SUPU Electronics Co., Ltd.

Address: No. 150, Xinxing 4th Road, High-tech Industrial Development Zone,
Cixi City, Zhejiang Province, China

Zip code: 315303

Switchboard: +86 574-63288158

Fax: +86 574-63288170

E-mail:supucontact@supu.cn

Service Hotline: 400-626-6336

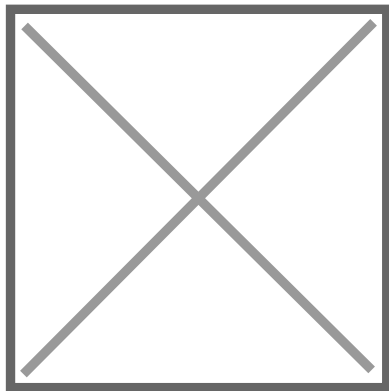

Wechat

Date:2026-05-05 09:15

The right to modify data belongs to SUPU.