



Product Type: Plug-in terminal-Socket

Product Name:MC-PF3.81H13P-K-0001

Product Description: Pitch: 3.81mm Rated Voltage : 160V Rated Current: 8A Connection method : Push in Connection colour : customizable

Product Size

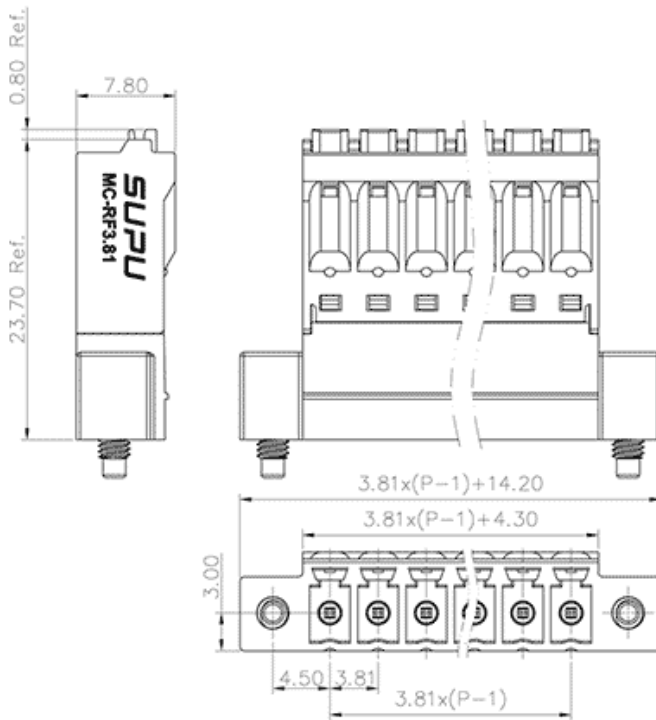

Parameters

⌘ SUPU ID	MC-PF3.81H13P-K-0001
⌘ Pitch	3.81
⌘ Number of levels	Single layer
⌘ Number of connections	13

☞ Connection method	Push in connection
☞ Protection Level	IP20
☞ Operating temperature range	-40~+105°C
☞ Insulation material	PA66
☞ Insulation material group	I
☞ Contact material	Copper alloy
☞ Contact plating	Sn,Plated
☞ Color	Green/Black/Blue/Grey/Orange/Red

Technical data

☞ IEC Rated Current	160V
☞ IEC Rated Voltage	8A
☞ Overvoltage category	III III II
☞ Degree of pollution	3 2 2
☞ Rated impulse voltage	2.5KV 2.5KV 2.5KV
☞ UL Rated Current	8A 8A 8A
☞ UL Rated Voltage	150V 50V 150V
☞ Conductor cross section rigid	0.2-1.5mm ²
☞ Conductor cross section flexible	0.2-1.5mm ²
☞ Conductor cross section flexible,with furrule	0.2-1.5mm ²
☞ Stripping length	10mm
☞ Use group	B/C/D
☞ Rated cross section	24-16AWG

Commercial data

Ningbo SUPU Electronics Co., Ltd.

Address: No. 150, Xinxing 4th Road, High-tech Industrial Development Zone,
Cixi City, Zhejiang Province, China

Zip code: 315303

Switchboard: +86 574-63288158

Fax: +86 574-63288170

E-mail:supucontact@supu.cn

Service Hotline: 400-626-6336



Wechat