

Product Type: Plug-in terminal-socket

Product Name:MC-PA7.62H11-I-0002

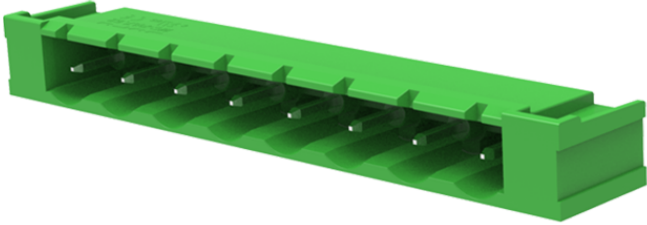

Product Description: Pitch: 7.62mm Rated Voltage : 630V Rated Current: 18A colour : customizable

Product Size

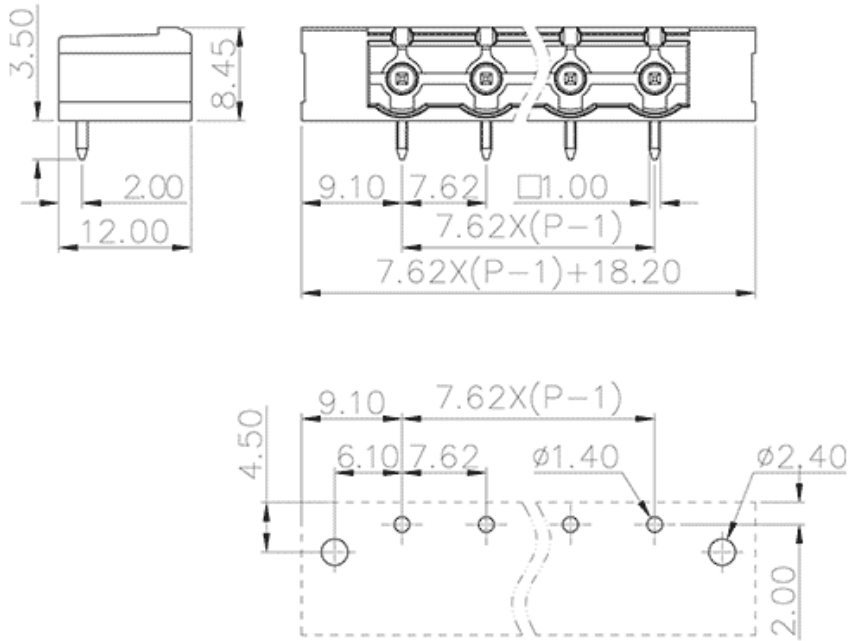

PCB LAYOUT

Parameters

☞ SUPU ID	MC-PA7.62H11-I-0002
☞ Pitch	7.62
☞ Number of levels	Single layer
☞ Number of connections	11

☞ Connection method	-
☞ Protection Level	IP20
☞ Operating temperature range	-40~+105°C
☞ Insulation material	PA66
☞ Insulation material group	I
☞ Contact material	Copper alloy
☞ Contact plating	Sn,Plated
☞ Color	Green/Black/Blue/Grey/Orange/Red

Technical data

☞ IEC Rated Current	630V
☞ IEC Rated Voltage	18A
☞ Overvoltage category	III III II
☞ Degree of pollution	3 2 2
☞ Rated impulse voltage	6.0KV 6.0KV 6.0KV
☞ UL Rated Current	15A - 10A
☞ UL Rated Voltage	300V - 300V
☞ Conductor cross section rigid	-
☞ Conductor cross section flexible	-
☞ Conductor cross section flexible,with ferrule	-
☞ Locking screw Specification	-
☞ Locking screw torque	-
☞ Fixed Screw Specification	-
☞ 固定螺钉扭矩	-

☞ Stripping length	-
☞ Use group	B/C/D
☞ Rated cross section	-

Commercial data

☞ Order No	MC-PA7.62H11-I-0002
------------	---------------------

Ningbo SUPU Electronics Co., Ltd.

Address: No. 150, Xinxing 4th Road, High-tech Industrial Development Zone,
Cixi City, Zhejiang Province, China

Zip code: 315303

Switchboard: +86 574-63288158

Fax: +86 574-63288170

E-mail:supucontact@supu.cn

Service Hotline: 400-626-6336



Wechat